

MALMBERGS

Evon Start WiFi/Bluetooth/4G

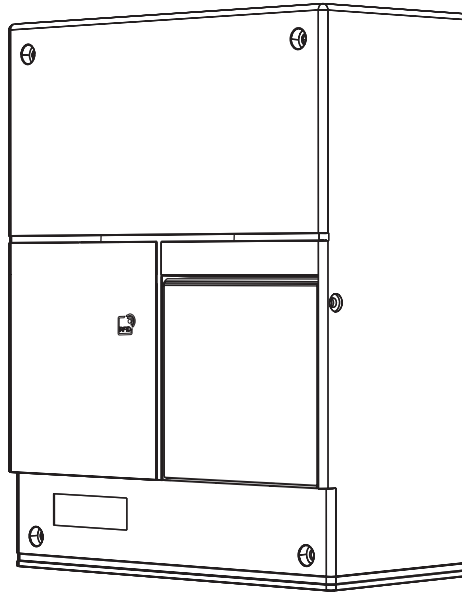

EN NOTE! Please read through the manual carefully before using the appliance and keep it for future reference.

WiFi Charging Station for Electric Vehicles

Content

1	SAFETY AND WARNINGS	3
2	Product Introduction	4
2.1	Product Features	4
2.2	Product Overview	4
2.3	Product Dimensions	5
3	ACCESSORIES	5
4	TECHNICAL SPECIFICATIONS	6
5	INSTALLATION	7-11
5.1	Required Material	7
5.2	Required Tools	7
5.3	Installation Procedure	8-11
6	Configure the Charger	12-13
6.1	Residential Scenario	12
6.2	Commercial Scenario	12-13
7	UNLOCK CHARGING CONNECTOR	14
8	INDICATOR	15
9	TROUBLESHOOTING	16
10	ROUTINE MAINTENANCE	17
11	STORAGE AND TRANSPORTATION	17
12	DISASSEMBLY	17
13	DISPOSAL/SCRAPPING	17

1 SAFETY AND WARNINGS

Caution

- Failure to follow instructions may result in danger.
- Children are prohibited from touching the charging station.
- Do not disassemble the charging station while connected to the mains.
- Install the charging station away from pyrotechnics, dusty or corrosive places.
- Only use the charging station when it is operating normally and please strictly follow the instructions.
- The charging station produces high-voltage output. You must pay attention to your personal safety when using it.
- If a malfunction happens, it may cause electric shock or even death. In emergency situations, cut off the power supply.

Maintenance/Installation

- Maintenance and installation must be performed by a qualified electrician.
- The product is carefully packed in the factory. During transportation, strong impact and bumps should be avoided to prevent damage to the outer packaging of the product.
- The product should be installed in an environment with an ambient temperature of $-30^{\circ}\text{C}\sim+50^{\circ}\text{C}$ and with a relative humidity of no more than 95%. The air should not contain acids, alkalis or other corrosive or explosive gases.
- Do not install in direct sunlight.
- When installing the charger outdoors, ensure its protected by an overhead water-proof shelter.

Safety Warning

Failure to follow instructions may result in danger!

- Regularly check whether the charging station has visible damage. There may be an electric shock hazard when operating a broken charging station.
- If a ground fault occurs, it must be assumed that the cable carries voltage. Please confirm that there's no high-voltage power in the system before inspecting the charging.
- Persons who install and use charging stations must obey the principles and regulations mentioned to ensure the personal safety and equipment safety.
- Before powering on the device, please confirm that the device is properly grounded to avoid unnecessary accidents.
- Under any circumstances, do not open, modify or install the device yourself.
- To ensure the service life and stable operation of the charging station, the operating environment should be kept as clean as possible with a relatively stable temperature and humidity. The charging station must not be used in flammable environments or environments with volatile gas.
- Please confirm that the input voltage, frequency, circuit breakers and other conditions of the device meet the specifications before the device is powered on.
- Cord extension sets are not allowed to be used.
- Adapters or conversion adapters are not allowed to be used.
- The device will stop charging automatically for safety, whenever a leakage current is detected. The RCD will be automatically reset when the AC leakage current is lower than 30mA and DC leakage current is lower than 6mA. You can start another charging session after the RCD is reset.
- The charger has built-in 30mA AC and 6mA DC leakage current detection, please install an external MCB before the charger.
- Test of RCD: Turn the MCB off and then on again, the charger will start the leakage current self-test automatically. Or press reset button 2 times within 2 second and the charger will start the leakage current self-test. It's recommended to test it every 6 months.
- Circuit breaker shall be installed at the power input side of the charger and shall comply with IEC 60898-1 or IEC 60947-2 or IEC 61009-1
- To test the RCD, please restart the circuit breaker, the charger will automatically perform a leakage self-test.

Overhaul

- The product warranty is valid for 5 years from the date of purchase. Please contact the dealer for complaints.
- Any direct damage or malfunction caused by neglect, incorrect use, installation, usage, repair by the users or natural damage are not covered by the warranty.

2 PRODUCT INTRODUCTION

Evon Start is a versatile and advanced EV charger, suitable for domestic use, offering up to 22kW of superfast charging. This OCPP-compliant unit supports pay-to-charge options through a mobile app or RFID, managed via any OCPP back-office system.

2.1 Product Features

- Plug to charge, mobile App and RFID controlled charging.
- Load balancing management.
- Over-the-air firmware updates.
- 4G/WiFi/Ethernet/Bluetooth connectivity.
- Independent back plate for easy installation or pole mounting.
- OCPP1.6 compliant (can integrate with any compatible back-office).
- Integrate photovoltaic green energy with electric power for charging.
- Energy monitoring.

2.2 Product Overview

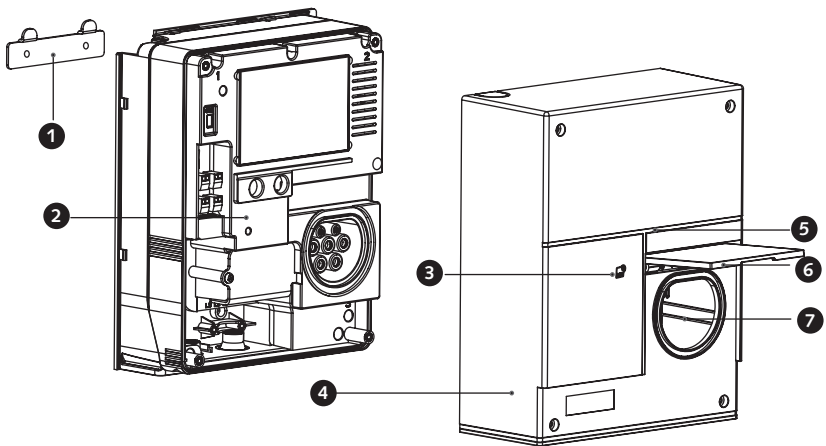

1. Mounting bracket
2. Core box
3. RFID card sensor
4. Enclosure





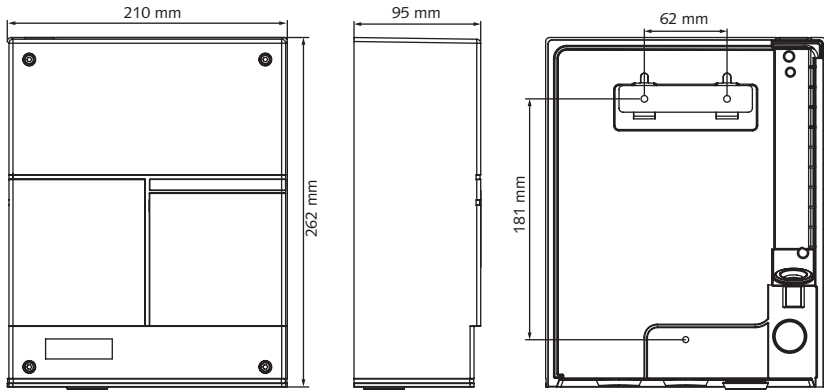











5. LED indicator
6. Socket cover
7. Charging socket

2.3 Product Dimensions

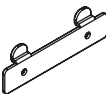

3 ACCESSORIES

When you receive the product, please ensure that the accessories are complete; if any are missing, please contact us.

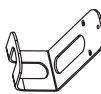
				
Wire ferrule (x5)	Cable clip (x1)	Wall plug (x4)	M4x32 screw (x6 cable version) (x3 socket version))	M3x12 screw (x2)
				
Seal cap (x1)	RFID card (x2)	Positioning diagram (x1)	M4x12 mm (x4)	M20 Communication cable gland (x1)
				
M25 Power cable gland (x1)	QR code label (x4)	Manual (x1)	Non-perforated cable gromme (x1)	Perforated cable grommet (x1)
				
Mounting bracket (x1)	Cable tie (x2)	Cable hook (x1 only for cable version)		

4 TECHNICAL SPECIFICATIONS

	Art.no.	27 012 38	27 012 39	27 012 40	27 012 41	27 014 51	27 014 52
	Model	AC022K-BE-55A	AC022K-AE-55A	AC011K-AE-55A		AC022K-BE-52A	
Input	Power supply	3P+N+PE					
	Rated voltage	400V AC					
	Rated current	32A	32A	16A	16A	32A	
	Terminal	Max 10 mm ²					
	Frequency	50/60Hz					
Output	Output voltage	400V AC					
	Maximum current	32A	32A	16A	16A	32A	
	Output power	22kW	22kW	11kW	11kW	22kW	
	Connector type	Type 2 Socket	Type 2 Cable	Type 2 Cable	Type 2 Cable	Type 2 Socket	
	Charging cable	-	5 m	5 m	7 m	-	
	Charging mode	Mode 3					
Connection	No. of phases	3-phase or 1-phase					
	Connection to mains	Terminal block					
	Grounding system	TN, IT, TT					
Description	Enclosure	PC (polycarbonate)					
	Colour	Black					
	LED indicator	Green/Yellow/Red					
Features	Start mode	RFID card (4pcs) / APP / Plug to charge					
	RFID reader	Mifare ISO/IEC 14443A				ISO/IEC 14443A (MifareClassic, Mifare DESFireDuox)	
	Supports load balancing	Yes					
	Energy monitoring	Yes (via app)					
Communication	WiFi	WiFi (2.4GHz)					
	4G	Incl. SIM card*					
	Bluetooth	Yes					
	Protocol	OCPP 1.6 Json/OCPP 2.0.1 Json (upgradeable)					
	ISO 15118	No					HW Ready, FM OTA
Environment	Installation	Wall-mount/Pole-mount					
	Working temperature	-30°C - +50°C					
General	Dims (WxHxD)	210x262x95 mm					
	Weight (excl. cable)	4 kg					
Safety	Ingress protection	IP54	IP65			IP54	
	Impact protection	IK10					
	Leakage Current Protection	30mA Type A + 6mA DC					
	Features	Over current protection, Residual current protection, Short circuit protection, Surge protection, Over/Under voltage protection, Over/Under frequency protection					
	Electrical protection class	Class I					
	Certificate	CE (Tested by Dekra)					
	Standards	EN IEC 61851-1:2019, EN IEC 61851-21-2:2021, IEC 62955:2018, IEC 62196					
	Warranty	5 years					

* See Terms and Conditions for 4G SIM card with 10 years of data

5 INSTALLATION











5.1 Required Material

Before installation, you will need to prepare the following accessories and cables on your own:

Item	Specification
Power cable	Operating current: max 32A, according to the specific installation scenario Cross section area: Max 10 mm ²
RJ45 connector	Standard
Ethernet cable	Cat.5e or higher, CSA: 0.2 ~0.25 mm ²
RS485 cable	22 to 24AWG shielded twisted pair

5.2 Required Tools

Before installation, you will need to prepare the following accessories and cables on your own:

Tool	Icon	Function
Tape ruler		5-meter
Electric screw driver		Approximately 2.2–2.8 Nm
Hammer		Standard 16 oz (450 g)
Wire stripper		/
Multimeter		/
Spirit level		/
Marker		/
Electric drill		6 mm drill bit
Wire cutter		/
Crimping pliers		/
Hydraulic clamp		/



The installer will need to prepare these tools by themselves.

5.3 Installation Procedure

- 1 Remove the core box from the enclosure.

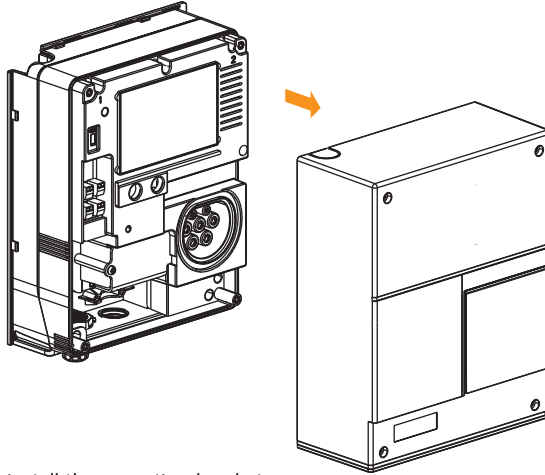

- 2 Drill holes and install the mounting bracket.

1. Affix the positioning diagram to the wall and mark the spots corresponding to the holes indicated on the diagram.
2. Create three holes at the marked locations using a drill.
3. Insert three wall plugs into the drilled holes.
4. Align the holes in the mounting bracket with the top two wall plugs, then secure it using the M4*32 screws.
5. Hang the charger onto the mounting bracket.
6. Secure the charger firmly to the wall by fastening the third M4*32 screw. Then, insert the waterproof rubber seal.

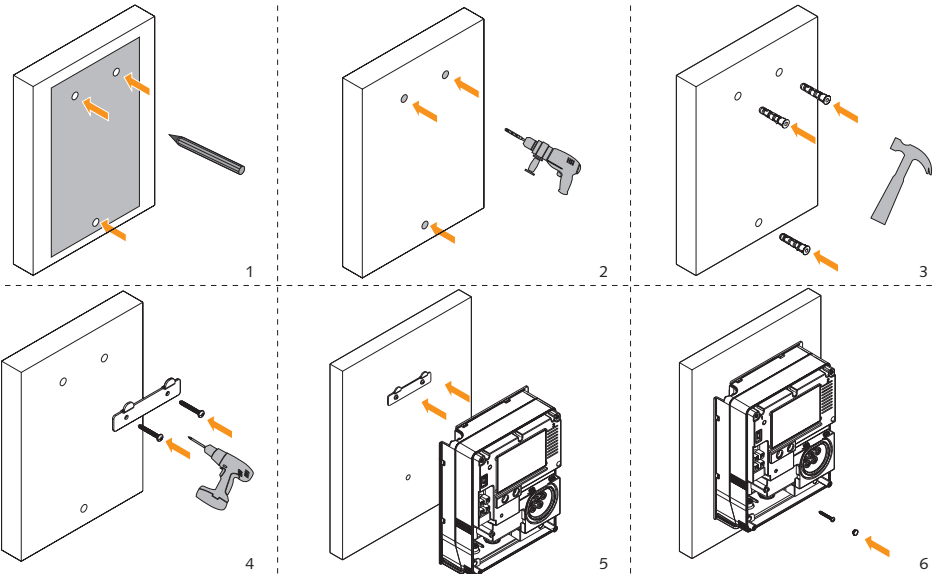

3 Connect AC input power cable

- Confirm the cable routing

As shown below, the cable can be routed into the charger from rear or bottom or top.

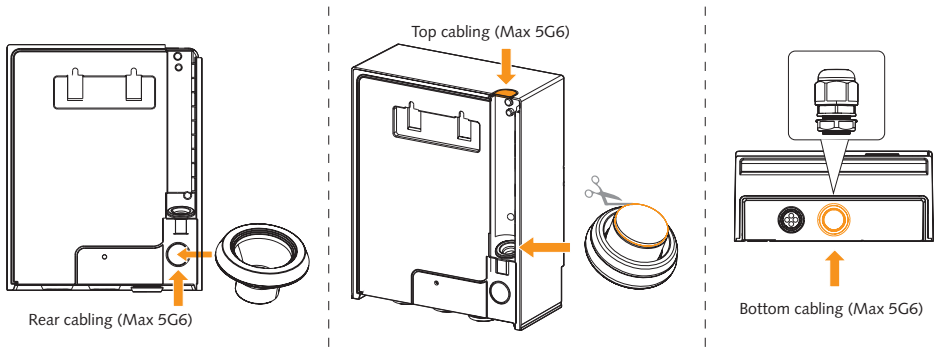

- If you choose bottom cabling, please replace the rubber plug in the charger with the cable gland to secure the cable.
- If you choose top cabling, please cut the non-perforated cable grommet along the indicated dotted line.
- If you choose rear cabling, please use the perforated cable grommet to secure the cable.

- Confirm the grid type

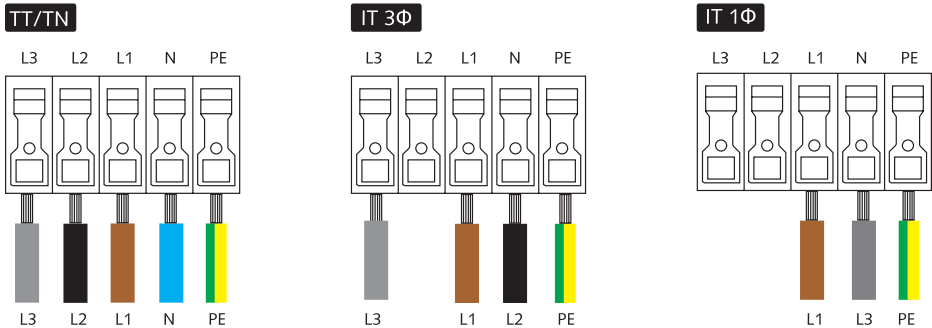

- Strip the wires and clamp the wire ferrules.

Pierce the rubber plug, then thread the cable through the opening.

Recommended cable / Wire stripping length:

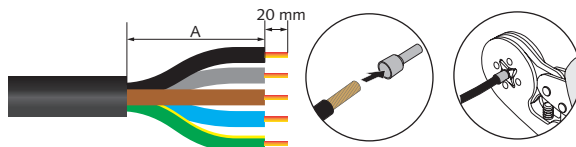

A	Bottom cabling	85 mm
	Rear cabling	115 mm
	Top cabling	115 mm

- Connect AC input cable to the terminal block.

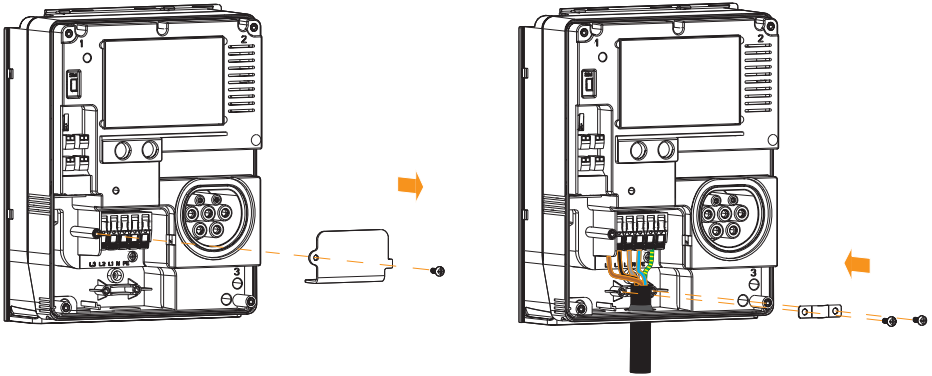

4 Connect communications cable & Insert 4G card

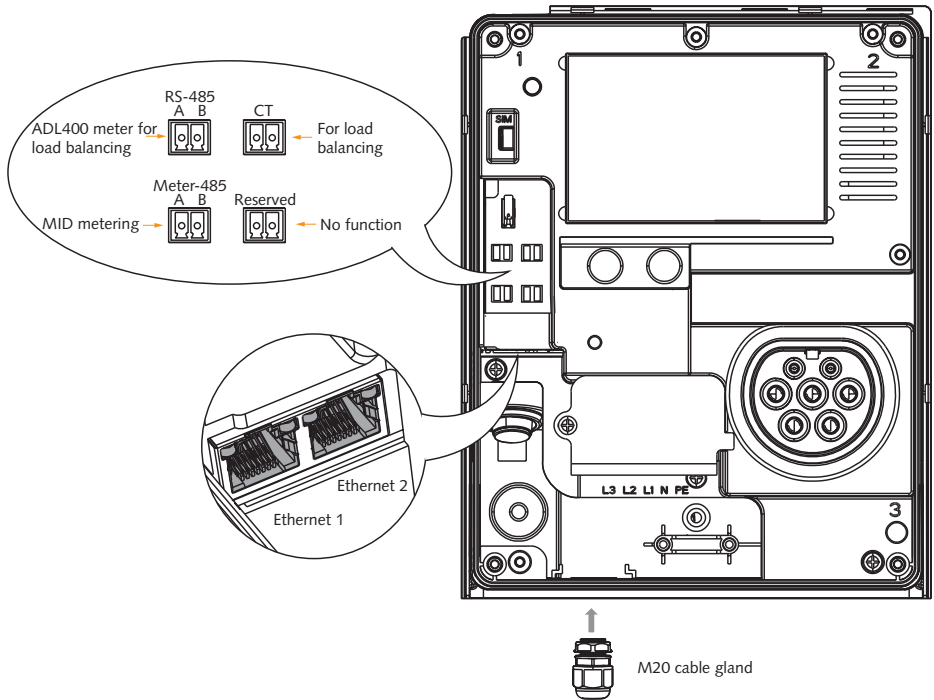

i To secure the communication when connecting it, please replace the rubber plug in the charger with the M20 cable gland.

- Connect Ethernet cable for networking

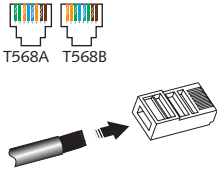

Daisy chain

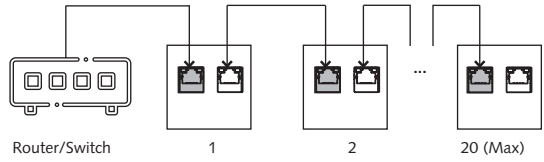

Please ensure that the Ethernet signal strength does not fall below 100Mbps for each charger and that the charging is working.

- Connect Ethernet cable for LBC UDP communication

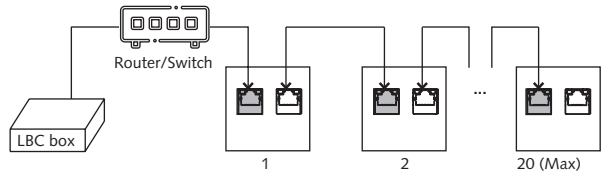
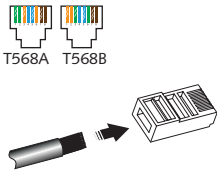

Insert SIM Card

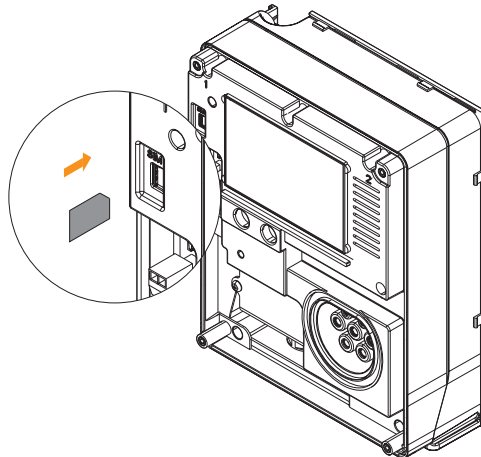

6 CONFIGURE THE CHARGER

6.1 Residential Scenario

Evcharge App is recommended for the charger used in a residential scenario.

- i** For an installer, you can download and install Evcharge App, and after completing all necessary configurations, you can transfer the ownership to the user. The user then simply install the App and log in to easily control the charging process with the App.

6.1.1 Download & Installation

Download and install the latest app on your smartphone.
Follow the instructions on the app to complete wizard settings and parameter settings.



App installation



App Quick Start Guide

6.2 Commercial Scenario

6.2.1 Configure Network via AP mode

AP mode is recommended to configure the network for the charger:

- Connect to Evcharge platform in a commercial scenario
- Connect to a 3rd party's platform, and use a 3rd party's App to charge EV.

- i** In Access Point (AP) mode, the charger acts as a temporary WiFi hotspot, allowing your phone to connect directly it for network setup.

For the instructions of AP mode, please scan the QR code below



- i** The hotspot of the charger remains available for 30 minutes.

Press the 'Reset' button if needed as shown below, and that it will do self test (leakage test)

- Press the "Reset" button twice within 2s to reboot and reactivate the WiFi hotspot.
- Press the "Reset" for 5s to reset the PIN codes for AP and Bluetooth password.

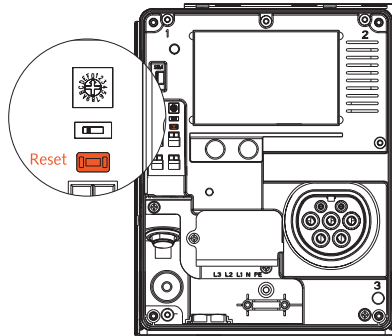

6.2.2 Evcharge cloud platform

For managing your chargers after network setup, you might find it beneficial to use a smart management platform. Evcharge Cloud is designed to cater to the needs of business operators for managing charging stations and monitoring chargers.

After you've purchased our charger and decided to use our platform, we will send you an account number and password via email. Use these credentials to log in to the Evcharge Cloud platform. Below is a QR code; scanning it will give you access to more detailed information on how to operate the platform.



Instructions for Evcharge Cloud

6.2.3 Install the enclosure

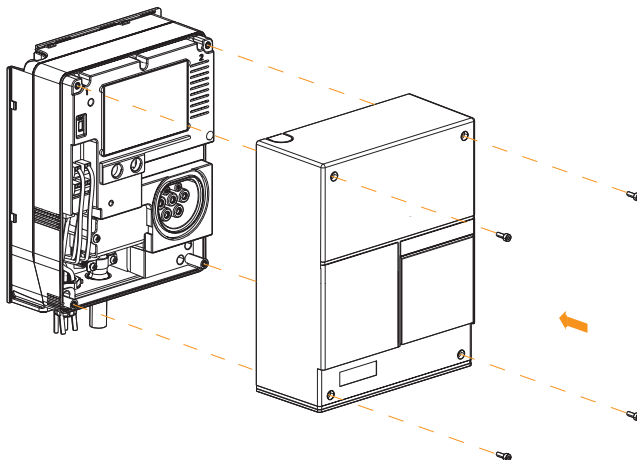

Attach the enclosure with core box, then finally secure it with screws at the four corners.

7 UNLOCK CHARGING CONNECTOR

In case the charging connector gets stuck and cannot be removed from the EV charger, follow the instructions below to safely release it.

1. Cut off the power supply.
2. Remove the enclosure.
3. Use a flat-head screwdriver to lever the rocker arm off and unlock the charging connector.

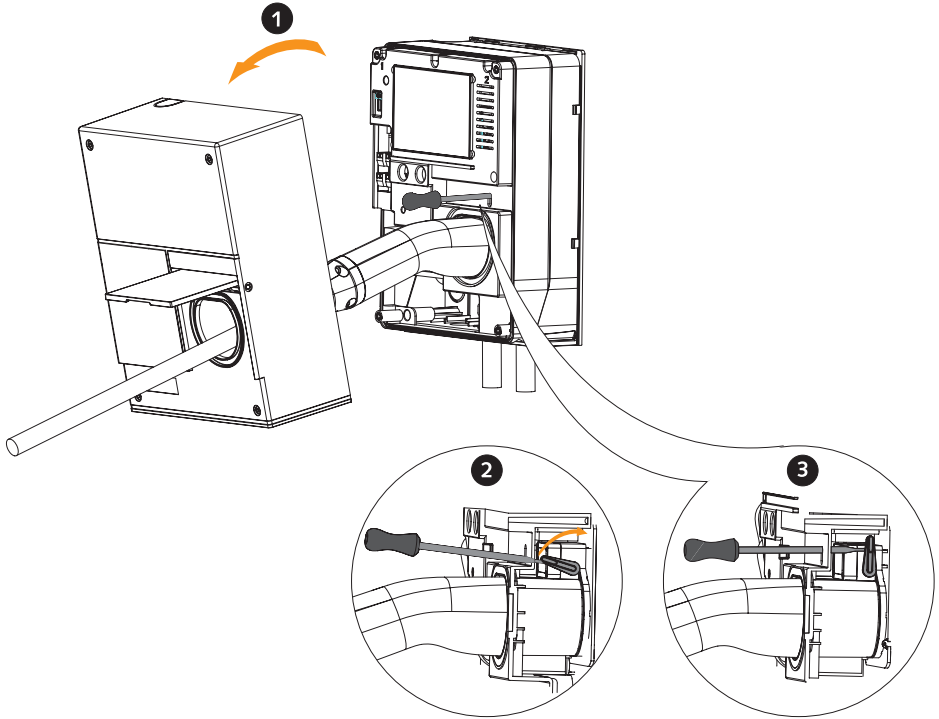

8 INDICATOR

Indicator color	EV charger status	Indicator status
Green	Standby	Cycle: slow flashing: on for 1s, then off for 3s.
	Charging initiated, awaiting vehicle response	Cycle: rapid flashing: on for 200ms, then off for 1000ms, twice; followed by a 3000ms off.
	Charging connector plugged in, ready for Charging	Cycle: rapid flashing: on for 200ms, then off for 1000ms, 5 times; followed by a 3000ms off.
	Charging in progress	Cycle: gradually brightens, then gradually dims, on for 1s, off for 1s.
	Charging completed	Steady green.
Yellow	No Network/Not Connected to Server	Cycle: the green indicator is on for 1s, followed by the yellow indicator on for 1s, then off for 3s.
	Bluetooth lock	Cycle: flashing: on for 4s, then off for 1s.
	Scheduled charging in Bluetooth mode	Cycle: flashing: on for 2s, then off for 2s.
	Insufficient Power Allocated, Pausing Charging	Cycle: rapid flashing : on for 200ms, then off for 1000ms, 5 times; followed by a 3000ms off.
	Card Identified Successfully	Cycle: rapid flashing: on for 100ms, then off for 100ms, 5 times (Max.).
	Charger Reserved (Occupied)	Cycle: rapid flashing: on for 2s, then off for 2s
	Alarm	Steady yellow.
White	Program is upgrading	Cycle: rapid flashing: on for 200ms, then off for 1000ms, 5 times; followed by a 5000ms off.
	Power-On Self-Test	Cycle: gradually brightens, then gradually dims, on for 1s, off for 1s.

9 TROUBLESHOOTING

Indicator color	EV charger status	Indicator status
Red	Relay adhesion	Steady red
	Leakage current fault	Cycle: on for 500ms, then off for 500ms, once; followed by 3s off.
	CP fault	Cycle: on for 500ms, then off for 500ms, 2 times; followed by 3s off.
	Overcurrent fault	Cycle: on for 500ms, then off for 500ms, 3 times; followed by 3s off.
	Reverse polarity fault	Cycle: on for 500ms, then off for 500ms, 4 times; followed by 3s off.
	Leakage current loop anomaly (self-check)	Cycle: on for 500ms, then off for 500ms, 5 times; followed by 3s off.
	Input terminal overheat fault	Cycle: on for 500ms, then off for 500ms, 6 times; followed by 3s off.
	Relay Overheat	Cycle: on for 500ms, then off for 500ms, 7 times; followed by 3s off.
	Output voltage fault	Cycle: on for 500ms, then off for 500ms, 9 times; followed by 3s off.
Red + Yellow	Undervoltage fault	Cycle: yellow on for 2s, followed by the red flashing once (on for 500ms, off for 500ms), then 3s off.
	Overvoltage fault	
	Overfrequency fault	Yellow on for 2s, followed by the red flashing twice (on for 500ms, off for 500ms), then 3s off.
	Underfrequency fault	
Red + Yellow	Meter communication failure (for chargers with meters)	Yellow on for 2s, followed by the red flashing 3 times (on for 500ms, off for 500ms), then 3s off.
	Smart meter communication failure	Yellow on for 2s, followed by the red flashing 4 times (on for 500ms, off for 500ms), then 3s off.
	Current transformer (CT) anomaly	Yellow on for 2s, followed by the red flashing 5 times (on for 500ms, off for 500ms), then 3s off.
	Charging connector lock anomaly	Yellow on for 2s, followed by the red flashing 6 times (on for 500ms, off for 500ms), then 3s off.
	Charging connector current anomaly	Yellow on for 2s, followed by the red flashing 7 times (on for 500ms, off for 500ms), then 3s off.
	Output short circuit	Yellow on for 2s, followed by the red flashing 9 times (on for 500ms, off for 500ms), then 3s off.
White	BOOT security verification failed or security chip is malfunctioning	Flashing white : on for 200ms, then off for 1000ms twice, followed by 5000ms off.
	The charger is unavailable	Steady white

10 ROUTINE MAINTENANCE

Chargers do not need special maintenance. You are advised to check and clean the enclosure of the charger and accessories such as the charging connector every six months.

Check whether the charger and cables are damaged.

Use a dry cloth to clean the surface of the charger. Do not spray water directly on the charger.



Do not use corrosive cleaners, glass cleaners, or organic solvents.

11 STORAGE AND TRANSPORTATION

Chargers should be transported in the original packages. Do not place other objects on the top of the charger.

Before transportation, store the product in a clean, dry, and well ventilated place with a relative humidity of not more than 80% and free from corrosive gases.

The environmental specifications for storage and transportation shall not go beyond those specified in the Technical Specifications.

12 DISASSEMBLY

Only authorized and qualified electricians are allowed to disassemble the product.

Power off the charger before disassembling it. Disassemble a charger in the reverse order of installation.

13 DISPOSAL/SCRAPPING

The product should be disposed of at recycling points for electronic equipment. Dispose of the product in a correct and environmental friendly manner in compliance with local laws and regulations.

Electronic devices cannot be disposed of as household waste.

MALMBERGS

EU Declaration of Conformity

Manufacturer name: Malmbergs Elektriska AB (publ)
Manufacturer address: PO Box 144, SE-692 23, Kumla, SWEDEN
Product name: Evon Start
Product number: 27 012 38, 27 01239, 27 012 40, 27 012 41, 27 014 51, 27 012 52
AC022K-BE-55A, AC022K-BE-52A, AC022K-AE-55A, AC011K-AE-55A

This declaration of conformity is issued under the sole responsibility of the manufacturer.
The product above is in conformity with the provisions of the following directives/standards:

RED 2014/53/EU	Standards
3.1(a)	EN IEC 61851-1:2019 EN IEC 62311:2020 EN 301489-1 V2.2.3:2019 EN 301489-3 V2.3.2:2023 EN 301489-17 V3.3.1:2024 EN 301 489-52 V1.3.1:2024
3.1(b)	EN IEC 61000-6-1:2019 EN IEC 61000-6-2:2019 EN IEC 61000-6-3:2021 EN IEC 61000-6-4:2019 EN IEC 61851-21-2:2021
3.2	EN 300328 V2.2.2:2019 EN 300330 V2.1.1:2017 EN 301908-1 V15.2.1:2023 EN 301908-13 V13.2.1:2022
3.3(d)	EN 18031-1:2024

RoHS 2011/65/EU	Harmonized Standards
	EN IEC 63000:2018

Additional Information

The product includes integrated residual current detection in accordance with IEC 62955:2018.

For and on behalf of:



Malmbergs Elektriska AB, Sweden.
Mr. Anders Folke / Product Manager
Date: 26/05/2026

PIN CODE

MALMBERGS

Malmbergs Elektriska AB, PO Box 144, SE-692 23 Kumla, SWEDEN
Phone: +46 19 58 77 00 info@malmbergs.com www.malmbergs.com